

Three Phase Multifunctional Energy Meter

SDM630-TCP

User manual V1.2



Zhejiang Eastron Electronic Co.,Ltd.

Statements

All rights reserved. Without the written permission of the company, no paragraphs or chapters in this manual can be extracted, copied or reproduced in any form. Otherwise, the violator shall bear all consequences.

The company reserves all legal rights.

The company reserves the right to amend the product specifications in this manual without prior notice. Before placing an order, please contact our company or local agent to get the latest specifications.

Content

Chapter 1. Introduction	- 1 -
1.1 Introduction	- 1 -
1.2 Product Characteristics	- 1 -
1.3 Application	- 1 -
Chapter 2. Technical Parameters	- 2 -
2.1 Technical parameters	- 2 -
2.2 Accuracy	- 2 -
2.3 Ethernet communication	- 2 -
2.4 Performance criteria	- 3 -
2.5 Dimensions	- 3 -
2.6 Wiring diagram	- 3 -
Chapter 3. Operation	- 4 -
3.1 Installation display	- 4 -
3.2 Button Function:	- 4 -
3.3 Measurements	- 5 -
3.3.1 Voltage and current	- 5 -
3.3.2 Frequency, Power factor and Demand	- 5 -
3.3.3 Power	- 6 -
3.3.4 Energy	- 7 -
3.4 Setup Mode	- 8 -
3.4.1 Password Validation	- 8 -
3.4.2 Communication Address	- 8 -
3.4.3 Demand Interval Time setup	- 9 -
3.4.4 Backlit Power Time Setup	- 9 -
3.4.5 System Type Setup	- 10 -
3.4.6 Password Modification Setup	- 10 -
3.4.7 Ethernet information Setup	- 10 -
3.4.8 Reset	- 12 -
Chapter 4. Communication	- 14 -
4.1 Connection Diagram for Communication	- 14 -

Chapter 1. Introduction

1.1 Product Introduction

SDM630-TCP is a new multi-function energy meter designed by EASTRON. The meter can work with 1p2w, 3p3w, 3p4w electricity grid. It provides all important electrical parameters: voltage, current, power, PF, THD, frequency, demand, energy etc. The meter supports max.100A direct connection, saving the cost and avoiding the trouble to connect external CTs, giving the unit a cost-effective and easy operation.

The meter SDM630-TCP is equipped with a Ethernet communication port and MODBUS-TCP protocol is adopted for remote reading and programming. The meter has a big back-lighted LCD showing data and uses 4 touch keypads in front for data checking and programming.

1.2 Product Characteristics

- 100A direct load
- Multi-parameters measurement
- Plug-in solution
- LCD with white backlit, adjustable backlit time

Measurements:

- Phase voltage: V1, V2, V3
- Line voltage: V1-2, V2-3, V3-1
- Current: I1, I2, I3
- Active power: P1, P2, P3, P_total (total active power)
- Reactive power: Q1, Q2, Q3, Q_total (total reactive power)
- Apparent power: S1, S2, S3, S_Total (total apparent power)
- Frequency: Hz
- Power factor: PF
- Active energy: Ep_imp (import active energy), Ep_exp (export active energy), Ep_total (total active energy)
- Reactive energy: Eq_imp (import reactive energy), Eq_exp (export reactive energy), Eq_total (total reactive energy)
- THD-I and THD-U
- Maximum demand: MD

Setup:

- Ethernet setup
- Demand Interval Time
- Backlit time
- Supply system 1p2w, 3p3w,3p4w
- Reset
- Password modification

1.3 Application

SDM630-TCP supports Modbus-TCP for easy integration with other I/O and SCADA system.

Chapter 2. Technical Parameters

2.1 Technical parameters

- ◆ Voltage AC (Un): 3*230/400VAC
Voltage range: 100 - 276V a.c. (not for 3p3w supplies)
Voltage between phase: 173 to 480V a.c (3p supplies only)
- ◆ Current input:
Basic current (Ib): 10A
Maximum current (Imax): 100A
Over current withstand: 30Imax for 0.01s
- ◆ Frequency:
Rated value: 50/60Hz,
Range: 45 - 65Hz
- ◆ Voltage withstand:
AC voltage withstand: 4KV/1min
Impulse voltage withstand: 6kV – 1.2μS waveform
- ◆ Power consumption: ≤ 2W/10VA
- ◆ Display: LCD with white backlit
- ◆ Max. reading: 999999.99 kWh/kVArh

2.2 Accuracy

- ◆ Voltage: 0.5%
- ◆ Current: 0.5%
- ◆ Frequency: 0.2%
- ◆ Power factor: 1%
- ◆ Active power: 1%
- ◆ Reactive power: 2%
- ◆ Apparent power: 1%
- ◆ Active energy: Class1
- ◆ Reactive energy: Class2

2.3 Ethernet communication

- ◆ Type: Ethernet
- ◆ Protocol: Modbus-TCP
- ◆ Modbus address range: 1-247
- ◆ IP: 192.168.1.200 (default)
- ◆ Port: 502
- ◆ MASK: 255.255.255.0
- ◆ Gateway: 192.168.1.1
- ◆ DHCP: Off (default)

2.4 Performance criteria

- ◆ Operation humidity: $\leq 90\%$
- ◆ Storage humidity: $\leq 95\%$
- ◆ Operating temperature: $-25^{\circ}\text{C}\sim+55^{\circ}\text{C}$
- ◆ Storage temperature: $-40^{\circ}\text{C}\sim+70^{\circ}\text{C}$
- ◆ International standard: IEC62053-21
- ◆ Accuracy class: Class 1
- ◆ Installation category: CATIII
- ◆ Protection against penetration of dust and water: IP51 (indoor)
- ◆ Insulating encased meter of protective class: II
- ◆ Altitude: $\leq 2000\text{m}$

2.5 Dimensions

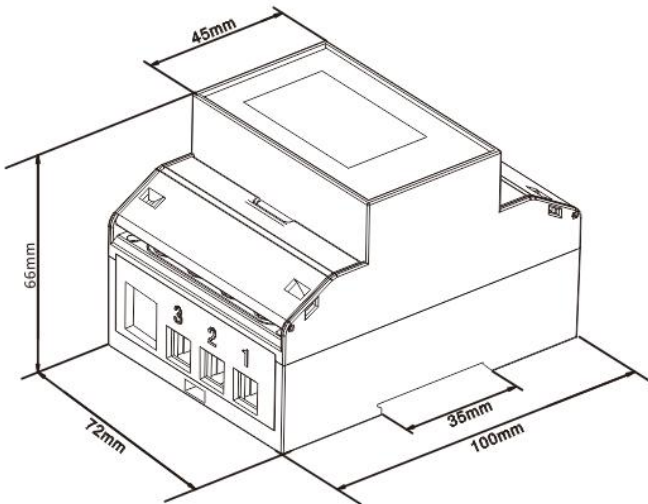

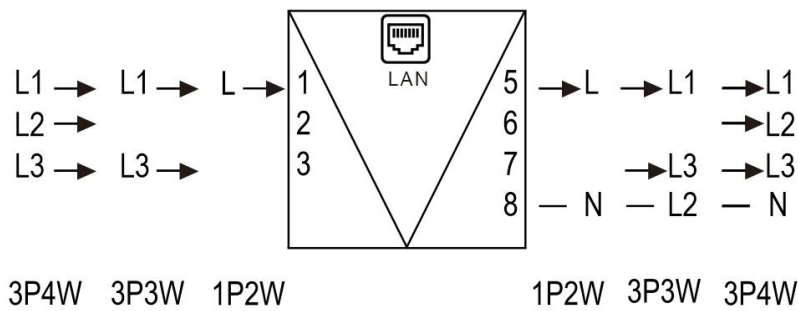

Height: 100mm
Width: 72mm
Depth: 66mm

2.6 Wiring diagram





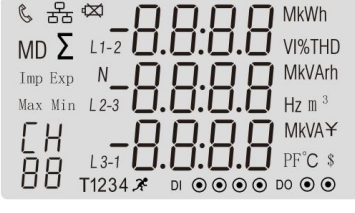

Chapter 3. Operation

3.1 Installation display

	<p>The first screen lights up all display segments and can be used as a display check.</p>
	<p>The second screen indicates the firmware installed in the unit. Note: the actual display might be different with the left on here.</p>
	<p>The interface performs a self-test and indicates the result if the test passes.</p>



3.2 Button Functions:

Button	Short click		Long press (3s)	
	Display mode	Setup mode	Display mode	Setup mode
	V1 V2 V3 V1-2 V2-3 V3-1 I1 I2 I3 V %THD I %THD	Return to previous menu		
	Hz PF PF1 PF2 PF3 MD of I1 I2 I3 MD of Power	Previous page or increase value		
	P1 P2 P3 Q1 Q2 Q3 S1 S2 S3 P-t Q-t S-t	Next page or decrease value		
	Active E-t Reactive E-t Imp Active E Exp Active E Imp Reactive E Exp Reactive E	Move to right side	Get into Setup mode	Confirm setting

3.3 Measurements

3.3.1 Voltage and current

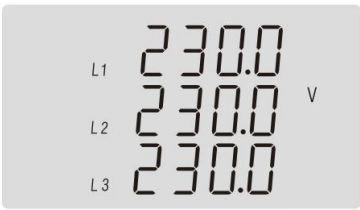
Each successive pressing of the  button selects a new range:

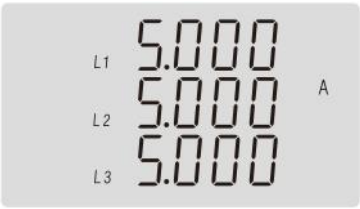
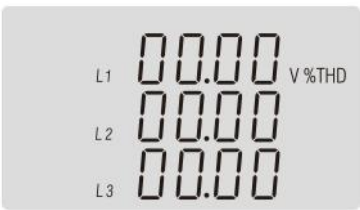
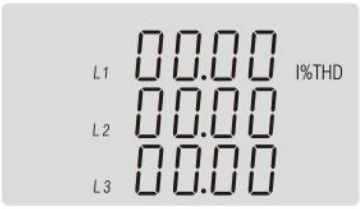
	Phase to neutral voltage
	Phase to phase voltage
	Current on each phase
	Phase to neutral voltage THD%
	Phase to neutral current THD%

3.3.2 Frequency, Power factor and Demand

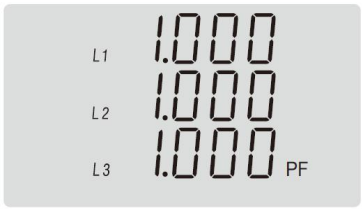
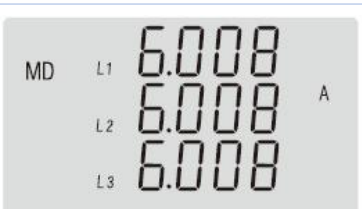
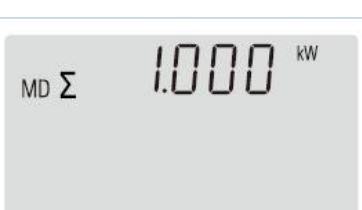

Each successive pressing of the  button selects a new range:

	Frequency and Power Factor (total)
	Power Factor of each phase
	Maximum current demand on each phase
	Maximum total power demand

3.3.3 Power

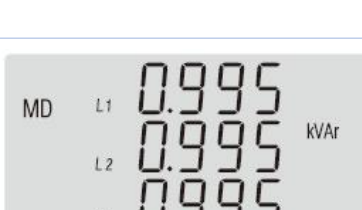

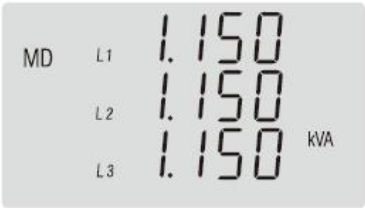
Each successive pressing of the  button select a new range:



	Instantaneous Active Power in kW
	Instantaneous Reactive Power in kVAr

	Instantaneous Volt-amps in kVA
	Total kW, kVArh, kVA

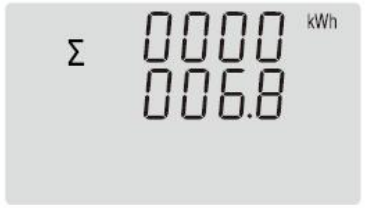
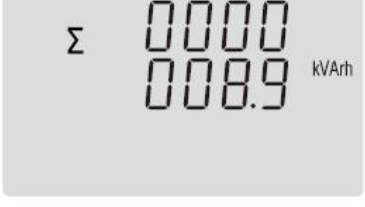
3.3.4 Energy





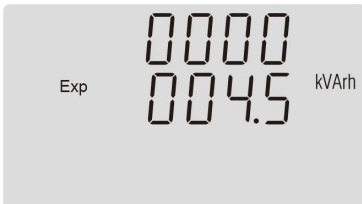

Each successive pressing of the  button shows following measurements:



















	Total active energy in kWh
	Total reactive energy in kVArh
	imported active energy in kWh

	Exported active energy in kWh
	Imported reactive energy in kVArh
	Exported reactive energy in kVArh

3.4 Setup Mode

The meter's settable parameters are password protected. By long pressing the 4th button "E", the user can get into the setup mode.

3.4.1 Password Validation	
	<p>Press button  and  to enter password.</p> <p>Long press button  for password confirmation.</p> <p>If an incorrect password is entered, the display will show "Err". If the password is correct, the unit will show the setup menu.</p> <p>Password: default 1000</p>
3.4.2 Communication Address	
	<p>Communication address setup</p> <p>Long press  to enter the setup</p> <p>Address range 001~247</p>



	<p>Communication address setup</p> <p>Long press button  to enter the setup mode.</p>
	<p>Press button  and  to set the addresses.</p> <p>Long press button  to confirm.</p> <p>Address range: 001 ~ 247, default 001.</p>
<h3>3.4.3 Demand Interval Time setup</h3>	
	<p>Long press button  to enter the setup.</p>
	<p>Press button  and  to set the demand period value.</p> <p>Long press button  to confirm.</p> <p>Option: 0,5, 8, 10, 15, 20, 30, 60(default) Unit: min.</p>
<h3>3.4.4 Backlit Power Time Setup</h3>	
	<p>Long press button  to enter the setup.</p>
	<p>Press button  and  to set the value.</p> <p>Long press button  to confirm.</p> <p>Option: ON, OFF, 5, 10, 30, 60(default), 120 mins ON means backlit always on, OFF means backlit always off.</p>

3.4.5 System Type Setup



Long press button  to enter the setup.



Press button  and  to setup the supply system.
 Option: 3P4W, 3P3W, 1P2W or 1P3W.

Long press button  to confirm.

Option: 3P4W(default), 3P3W, 1P2W, 1P3W.

3.4.6 Password Modification Setup



Long press button  to enter the setup mode.



Press button  and  to enter the new password.

Long press button  to confirm.

Range: 0000~9999, default 1000.

3.4.7 Ethernet information setup

3.4.7.1 DHCP function setup







Long press button  to enter the setup mode of TCP IP information.







Press button  and  to choose DHCP on or off.
 Default: off



3.4.7.2 TCP IP address setup









	Long press button  to set IP address.
	IP-High 192.168 (default)
	IP-Low 001.200 (default)

3.4.7.3 Subnet Mask address setup

	Long press button  to enter the setup mode.
	Subnet mask-High 255.255 (default)
	Subnet mask-Low 255.0 (default)

3.4.7.4 TCP gateway address setup

	Long press button  to enter the setup mode of IP address of TCP gateway
	TCP gateway address - High: 192.168 (default)
	TCP gateway address - Low: 001.001 (default)
3.4.7.5 TCP IP Port setup	
	Long press button  to enter the setup mode of TCP IP port
	TCP IP port: 502(default)
3.4.8 Reset This function allows user to reset data.	
	Long press button  to choose channel.

	<p>Channel Selection interface</p> <p>Press button  and  to choose channel (CH01-CH04).</p> <p>Long press  to enter the reset confirmation interface.</p>
	<p>Press button  and  to choose the data type.</p> <p>Long press button  to confirm. Reset done.</p> <p>Reset option: Max. demand, Max. value, Min. value</p>
<p>Note:</p>	
	<p>The left interface shows how to reset demand information.</p>

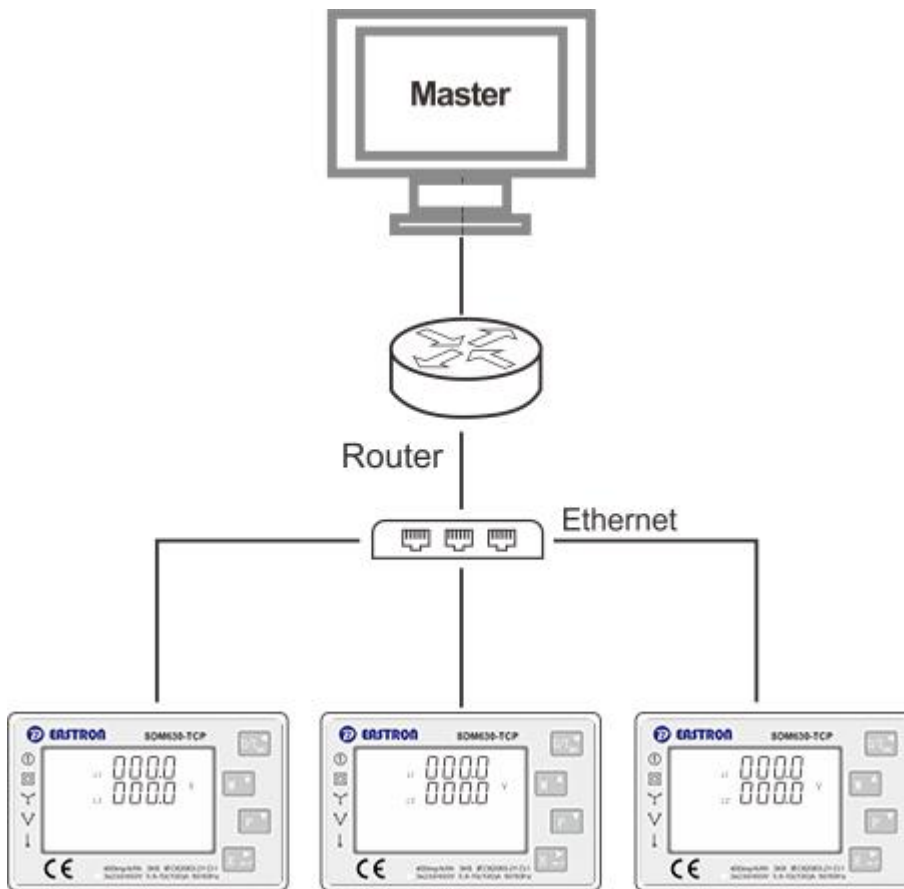
Chapter 4. Connection Diagram for Communication

If you have any question, please feel free to contact our sales team.

Zhejiang Eastron Electronic Co., Ltd.
No. 52, Dongjin Road, Nanhu, Jiaxing, Zhejiang, China
Tel: +86-573-83698881 Fax: +86-573-83698883
Email: sales@eastrongroup.com
www.eastrongroup.com

