

# Quad Loads Multifunctional Energy Meter

## SDM630MCT-ML-TCP

### User manual V1.0



# Zhejiang Eastron Electronic Co.,Ltd.

## Statements

All rights reserved. Without the written permission of the company, no paragraphs or chapters in this manual can be extracted, copied or reproduced in any form. Otherwise, the violator shall bear all consequences.

The company reserves all legal rights.

The company reserves the right to amend the product specifications in this manual without prior notice. Before placing an order, please contact our company or local agent to get the latest specifications.

## Content

<b>Chapter 1. Introduction.....</b>	<b>- 1 -</b>
1.1 Introduction.....	- 1 -
1.2 Product Characteristics.....	- 1 -
1.3 Application.....	- 2 -
<b>Chapter 2. Technical Parameters.....</b>	<b>- 2 -</b>
2.1 Technical parameters.....	- 2 -
2.2 Accuracy.....	- 2 -
2.3 Ethernet communication.....	- 2 -
2.4 Performance criteria.....	- 3 -
2.5 Dimensions.....	- 3 -
2.6 Wiring diagram.....	- 4 -
2.6.1 Three Phase 4 Wires.....	- 4 -
2.6.2 Three Phase 3 Wires.....	- 4 -
2.6.3 Single Phase 2 Wires.....	- 5 -
2.6.4 Single Phase 3 Wires.....	- 5 -
<b>Chapter 3. Operation.....</b>	<b>- 6 -</b>
3.1 Installation display.....	- 6 -
3.2 Button Function:.....	- 6 -
3.3 Measurements.....	- 7 -
3.3.1 Voltage and current.....	- 7 -
3.3.2 Frequency, Power factor and Demand.....	- 8 -
3.3.3 Power.....	- 9 -
3.3.4 Energy.....	- 10 -
3.4 Setup Mode.....	- 11 -
3.4.1 Password Validation.....	- 11 -
3.4.2 Communication Address.....	- 11 -
3.4.3 CT2 check.....	- 13 -
3.4.4 CT1 setup.....	- 13 -
3.4.5 Demand Interval Time setup.....	- 13 -
3.4.6 Backlit Power Time Setup.....	- 14 -

- 3.4.7 System Type Setup..... - 14 -
- 3.4.8 Password Modification Setup..... - 14 -
- 3.4.9 Ethernet information Setup ..... - 14 -
- 3.4.10 CT Reverse Connect Correction.....- 15 -
- 3.4.11 Reset.....- 18 -
- Chapter 4. Communication..... - 19 -**
- 4.1 Connection Diagram for Communication..... - 19 -

## Chapter 1. Introduction

### 1.1 Product Introduction

SDM630MCT-ML-TCP is a new multifunction energy meter designed by EASTRON for multi-channels measurements. The meter can work with 1p2w, 1p3w, 3p3w and 3p4w electricity grid, and it provides all important electrical parameters: voltage, current, power, PF, THD, frequency, demand, energy etc. By using plug-in connectors, the meter provides an easy click solution saving 80% installation time and avoiding wiring mistakes.

The SDM630MCT-ML-TCP is compactly designed. It can be used as 4x three phase energy meters or 12x single phase energy meters. 100mA (100mV optional) secondary external CT is required to work with the meter.

The meter SDM630MCT-ML-TCP is equipped with a Ethernet communication port and MODBUS-TCP protocol is adopted for remote reading and programming. The meter has a big back-lighted LCD showing data and uses 4 touch keypads in front for data checking and programming.

### 1.2 Product Characteristics

- 100mA CT connected (100mV optional)
- Multi-parameters measurement
- Plug-in solution
- LCD with white backlit, adjustable backlit time
- Quad loads measurement

#### Measurements:

- Phase voltage: V1, V2, V3
- Line voltage: V1-2, V2-3, V3-1
- Current: I1, I2, I3
- Active power: P1, P2, P3, P\_total (total active power)
- Reactive power: Q1, Q2, Q3, Q\_total (total reactive power)
- Apparent power: S1, S2, S3, S\_Total (total apparent power)
- Frequency: Hz
- Power factor: PF
- Active energy: Ep\_imp (import active energy), Ep\_exp (export active energy), Ep\_total (total active energy)
- Reactive energy: Eq\_imp (import reactive energy), Eq\_exp (export reactive energy), Eq\_total (total reactive energy)
- THD-I and THD-U
- Maximum demand: MD
- Max./Min. value: Max/Min

#### Setup:

- Ethernet setup
- CT1 value
- CT reverse connection
- Demand Interval Time
- Backlit time
- Supply system 1p2w, 1p3w,3p3w,3p4w
- Reset
- Password modification

## 1.3 Application

SDM630MCT-ML-TCP is suitable for scenarios where multi-loads are required.

## Chapter 2. Technical Parameters

### 2.1 Technical parameters

- ◆ Voltage AC (Un): 3\*230/400VAC  
Voltage range: 50 - 600VAC  
Auxiliary power supply: 85 - 300VAC
- ◆ Current input:  
Primary current input: 1 - 9999A  
Secondary current input: 100mA (optional: 100mV)  
Over current withstand: 20I<sub>max</sub> for 0.5s
- ◆ Frequency:  
Rated value: 50/60Hz,  
Range: 45 - 65Hz
- ◆ Voltage withstand:  
AC voltage withstand: 4KV/1min  
Impulse voltage withstand: 6kV – 1.2μS waveform
- ◆ Power consumption: ≤ 2W/10VA
- ◆ Display: LCD with white backlit
- ◆ Max. reading: 99999999 kWh/kVArh

### 2.2 Accuracy

- ◆ Voltage: 0.5%
- ◆ Current: 0.5%
- ◆ Frequency: 0.2%
- ◆ Power factor: 1%
- ◆ Active power: 0.5%
- ◆ Reactive power: 1%
- ◆ Apparent power: 1%
- ◆ Active energy: Class0.5S
- ◆ Reactive energy: Class1

### 2.3 Ethernet communication

- ◆ Type: Ethernet
- ◆ Protocol: Modbus-TCP
- ◆ Modbus address range: 1-247
- ◆ IP: 192.168.1.200 (default)

- ◆ Port: 502
- ◆ MASK: 255.255.255.0
- ◆ Gateway: 192.168.1.1
- ◆ DHCP: Off (default)

Note: SDM630MCT-ML-TCP has 2 modes of Modbus communication address. The modes can be set by pressing the buttons on the meter or via Ethernet Modbus TCP.

Mode 1: Single communication address mode. Under this mode, the register address of different channels (CH01-CH04) will be showed in segments. Channel 1(CH01) will be matched to 0~2999; Channel 2(CH02) 3000~5999; Channel 3(CH03) 6000~8999, and Channel 4(CH04) 9000~11999.

Mode 2: Multi communication addresses mode. Under this mode, each meter will have 4 different modbus addresses. Each channel (CH01-CH04) matches to one modbus address and all the channels share the same registers. The measurement data will be distinguished by different Modbus addresses. Therefore, each SDM630MCT-ML-TCP can be used as 4 normal meters.

Please check the protocol for detailed explanation of register codes.

## 2.4 Performance criteria

- ◆ Operation humidity:  $\leq 90\%$
- ◆ Storage humidity:  $\leq 95\%$
- ◆ Operating temperature:  $-25^{\circ}\text{C}\sim+55^{\circ}\text{C}$
- ◆ Storage temperature:  $-40^{\circ}\text{C}\sim+70^{\circ}\text{C}$
- ◆ International standard: IEC62053-22
- ◆ Accuracy class: Class 0.5S
- ◆ Installation category: CATIII
- ◆ Protection against penetration of dust and water: IP51 (indoor)
- ◆ Insulating encased meter of protective class: II
- ◆ Altitude:  $\leq 2000\text{m}$

## 2.5 Dimensions

Front View:

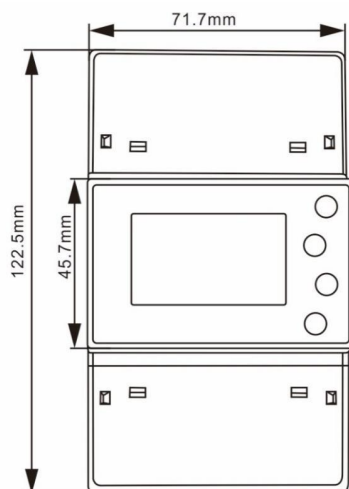

Side View:

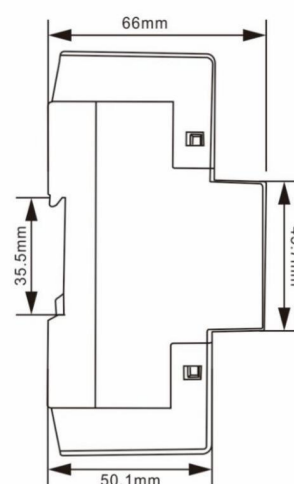

## 2.6 Wiring diagram

### 2.6.1 Three Phase 4 Wires

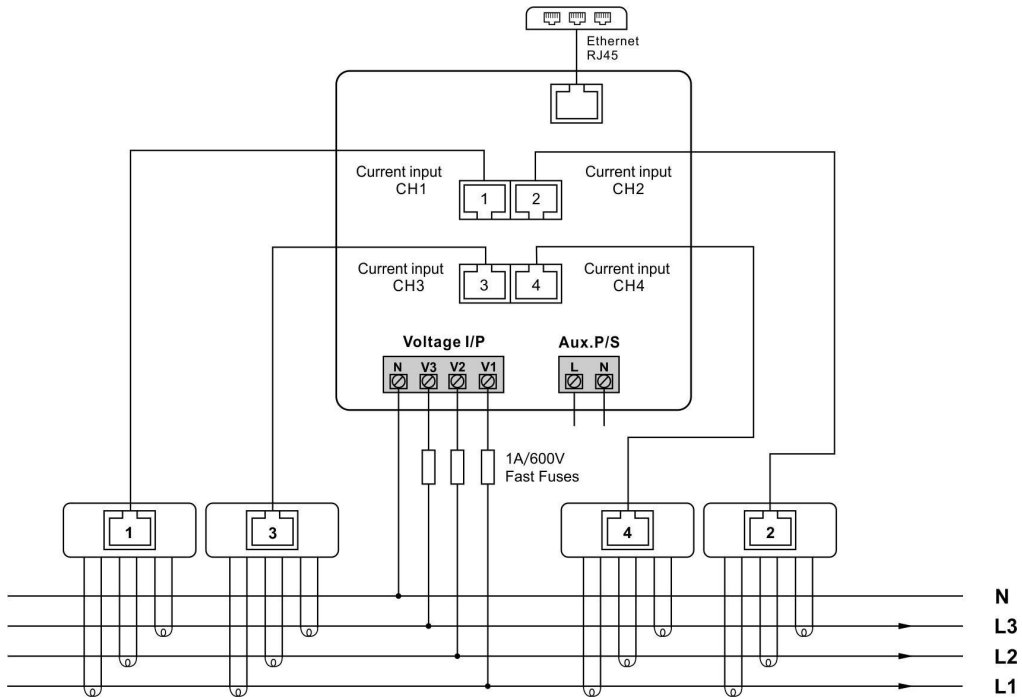

### 2.6.2 Three Phase 3 Wires

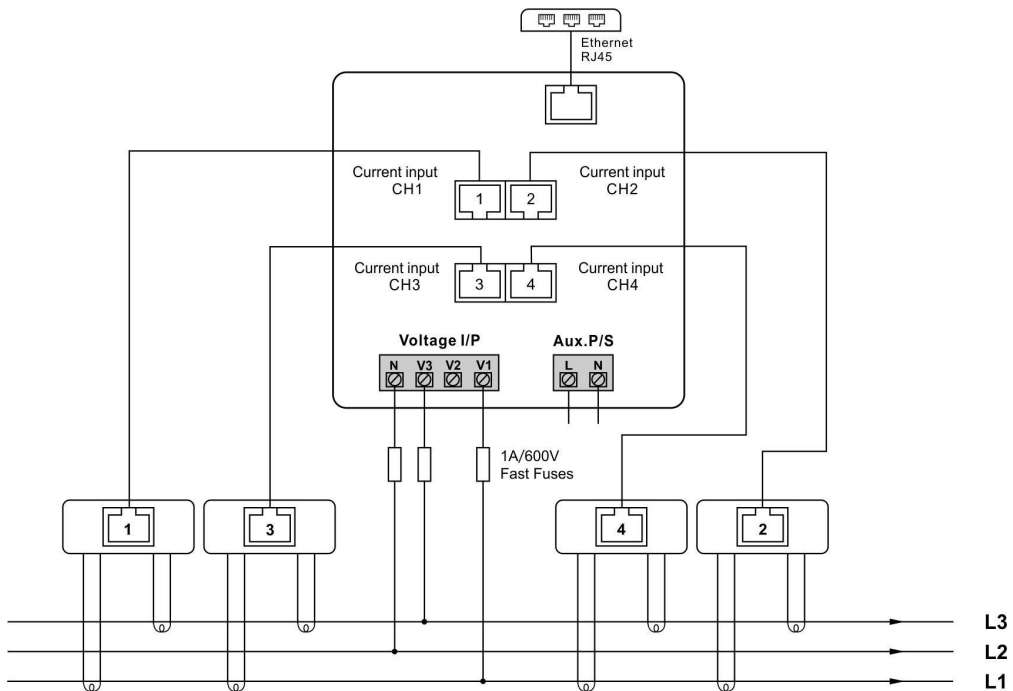



### 2.6.3 Single Phase 2 Wires

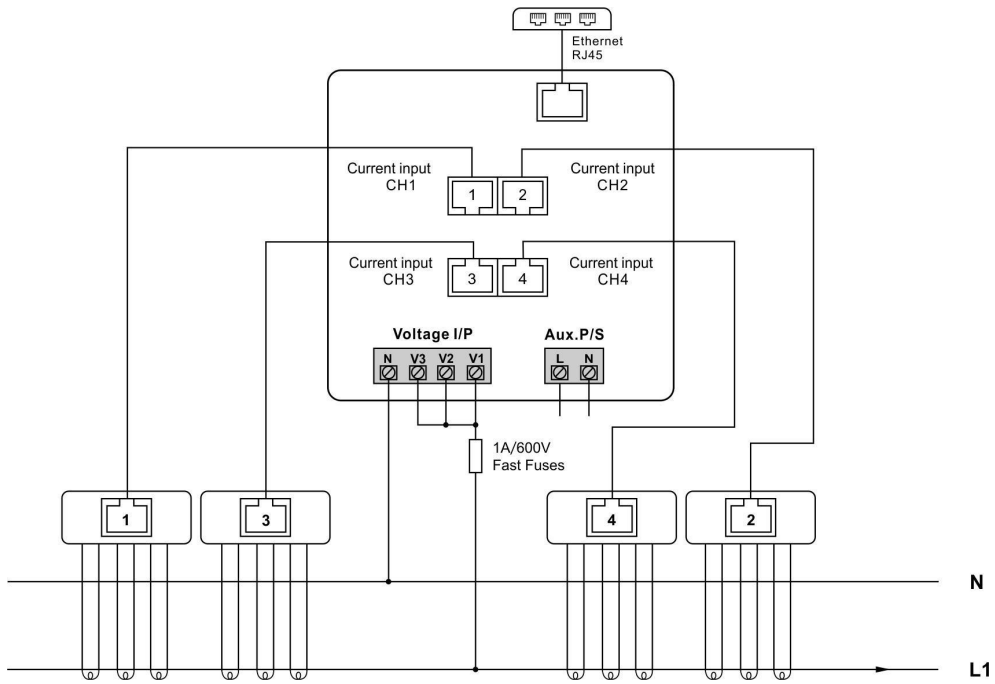

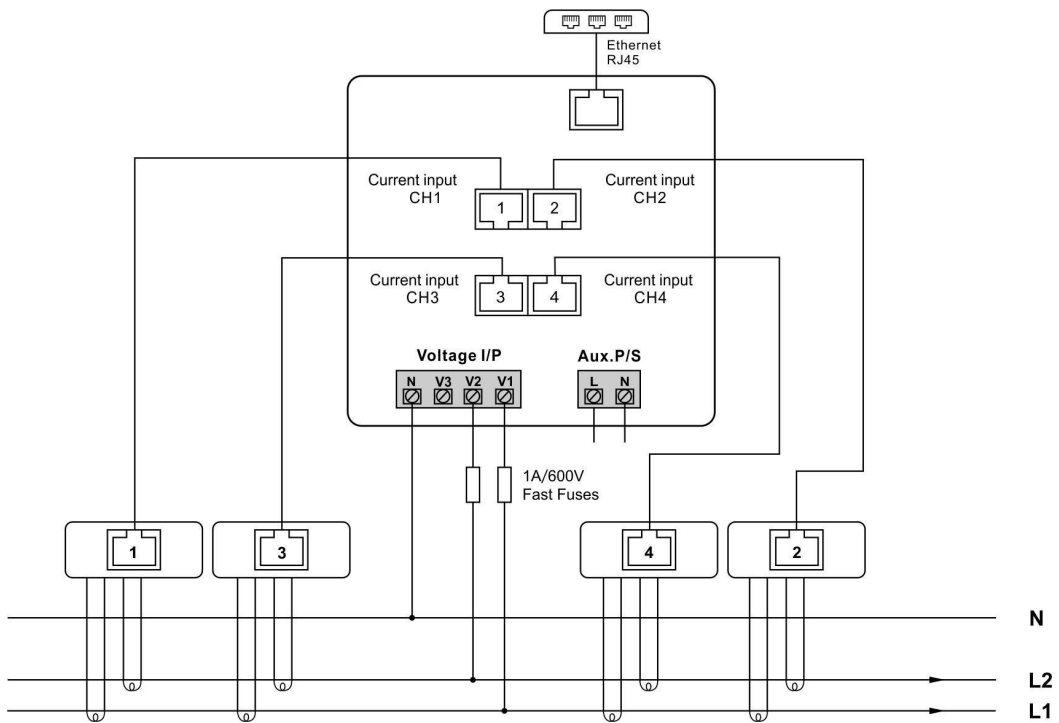

### 2.6.4 Single Phase 3 Wires





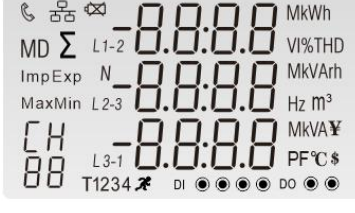

## Chapter 3. Operation

### 3.1 Installation display

	The first screen lights up all display segments and can be used as a display check.
	The second screen indicates the firmware installed in the unit. Note: the actual display might be different with the left on here.
	The interface performs a self-test and indicates the result if the test passes.



### 3.2 Button Functions:

Button	Short click		Long press (3s)	
	Display mode	Setup mode	Display mode	Setup mode
	V1 V2 V3 V1-2 V2-3 V3-1 I1 I2 I3 In V %THD I %THD	Return to previous menu		
	Hz PF PF1 PF2 PF3 MD of I1 I2 I3 MD of Power	Previous page or increase value	Check meter information (Address, IP-High, IP-Low, CT1, SWV, Full Screen)	
	P1 P2 P3 Q1 Q2 Q3 S1 S2 S3 P-t Q-t S-t	Next page or decrease value	Change Channel (CH01~CH04)	
	Active E-t Reactive E-t Imp Active E Exp Active E Imp Reactive E Exp Reactive E	Move to right side	Get into Setup mode	Confirm setting

### 3.3 Measurements

#### 3.3.1 Voltage and current

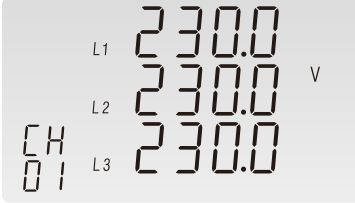
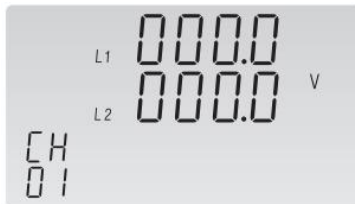
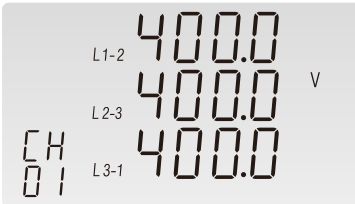
Each successive pressing of the  button selects a new range:

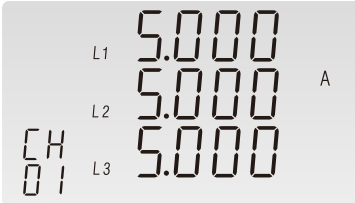
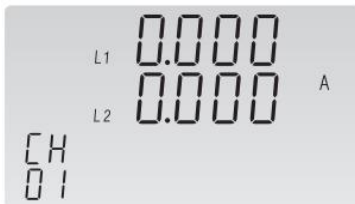
	Phase to neutral voltage
	Phase to neutral voltage(1p3w only)
	Phase to phase voltage
	Phase to phase voltage (1p3w only)
	Current on each phase
	Current on each phase(1p3w only)

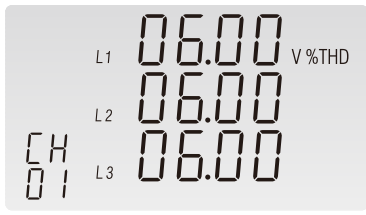
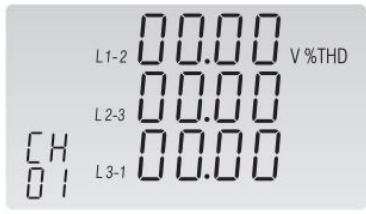
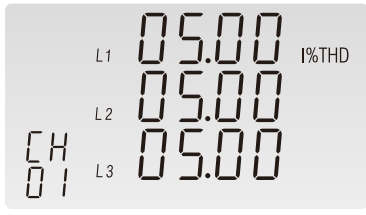
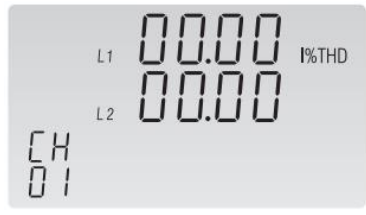
	Current on neutral
	Phase to neutral voltage THD%
	Phase to neutral voltage THD% (3p3w only)
	Phase to neutral current THD%
	Phase to neutral current THD%(1p3w only)

### 3.3.2 Frequency, Power factor and Demand

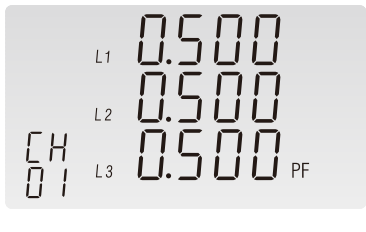
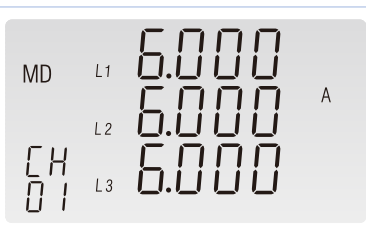
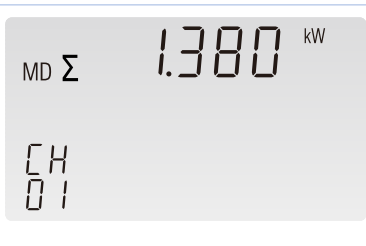

Each successive pressing of the  button selects a new range:

	Frequency and Power Factor (total)
---	------------------------------------

	Power Factor of each phase
	Maximum current demand on each phase
	Maximum total power demand

### 3.3.3 Power

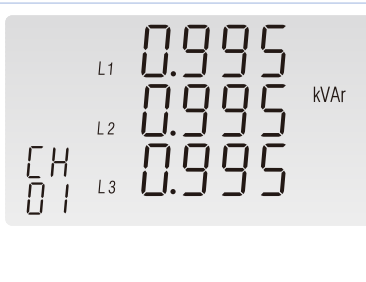
Each successive pressing of the  button select a new range:





	Instantaneous Active Power in kW
	Instantaneous Reactive Power in kVAR
	Instantaneous Volt-amps in kVA

 <p> <math>\Sigma</math> 1.725 kW            2.985 kVAr            CH 3.450 kVA            01         </p>	Total kW, kVArh, kVA
---	----------------------

### 3.3.4 Energy



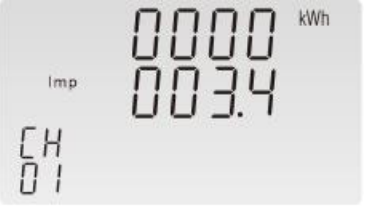



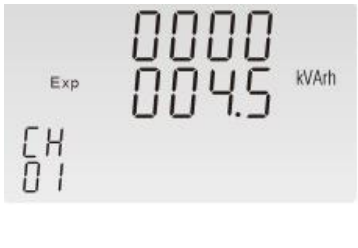



Each successive pressing of the  button shows following measurements:



















 <p> <math>\Sigma</math> 0000 kWh            006.8            CH            01         </p>	Total active energy in kWh
 <p> <math>\Sigma</math> 0000 kVArh            008.9            CH            01         </p>	Total reactive energy in kVArh
 <p>           Imp 0000 kWh            003.4            CH            01         </p>	Imported active energy in kWh
 <p>           Exp 0000 kWh            003.4            CH            01         </p>	Exported active energy in kWh
 <p>           Imp 0000 kVArh            004.4            CH            01         </p>	Imported reactive energy in kVArh

	Exported reactive energy in kVArh
---	-----------------------------------

### 3.4 Setup Mode

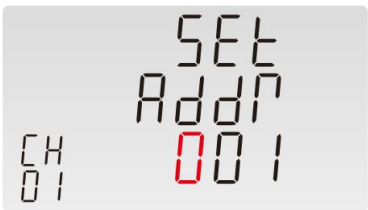
The meter's settable parameters are password protected. By long pressing the 4th button "E", the user can get into the setup mode.

<b>3.4.1 Password Validation</b>	
	<p>Press button  and  to enter password.</p> <p>Long press button  for password confirmation.</p> <p>If an incorrect password is entered, the display will show "Err". If the password is correct, the unit will show the setup menu.</p> <p>Password: default 1000</p>
<b>3.4.2 Communication Address</b>	
	<p>Communication address setup</p> <p>Long press  to enter the setup</p>
<b>3.4.2.1 Communication address modes(quantity) setup interface</b>	
<p>The meter has two communication address modes:</p> <ol style="list-style-type: none"> <li>1. Single communication address: there is only 1 address for the whole meter, and all channels use the same communication address.</li> <li>2. Multi communication addresses: There are 4 or 3 or 2 different communication addresses for different channels.</li> </ol>	
	<p>Communication address mode setup interface</p> <p>Long press  to enter the interface.</p>

	<p>Press  and  to setup communication address.</p> <p>Long press  to confirm.</p> <p>Option: 1, M* (default)</p> <p><b>1 means one communication address mode;</b>  <b>M* means multi communication addresses. It can be 2 or 3 or 4. It depends on the meter you have is for dual loads, or tri-loads or quad-loads.</b></p>
<p>3.4.2.2-1 Address setup, range 001~247 (one communication address mode)</p>	
	<p>Communication address setup</p> <p>Long press button  to enter the setup mode.</p>
	<p>Press button  and  to set the addresses.</p> <p>Long press button  to confirm.</p> <p>Address range: 001 ~ 247, default 001.</p>
<p>3.4.2.2-2 Address setup, range 001~247 (Multi communication addresses mode)</p>	
	<p>Address setup for corresponding channel</p> <p>Long press button  to enter the setup mode.</p> <p>Press button  and  to choose the channel (CH01-CH04) that need setting.</p>
	<p>Press button  and  to set the address.</p> <p>Long press  to confirm.</p> <p>Address range: 001 ~ 247, default 001</p>



### 3.4.3 CT2 check



Check only, not settable.

Note: if the unit is 100mA input version, the CT2 check will show 0.1A.

### 3.4.4 CT1 setup



Long press button  to enter the setup.



Press button  and  to choose the right channel (CH01-CH04).

Long press button  to enter the setup interface of CT1 of each phase.



Choose the phase to be set

Press button  and  to choose the phase(L1, L2, L3)

Long press  to enter the CT1 setup interface



CT1 setup interface

Press button  and  to set the CT1 value.











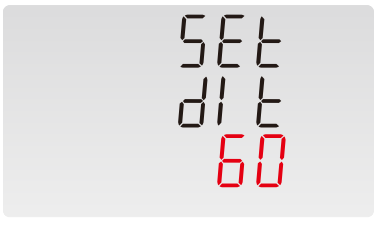







Long press  to confirm.

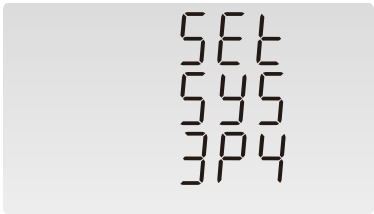









CT1 range: 1~9999 A, default 100 A







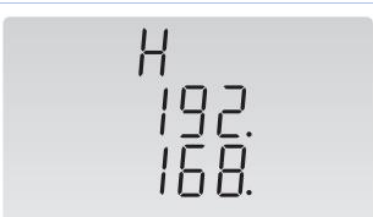
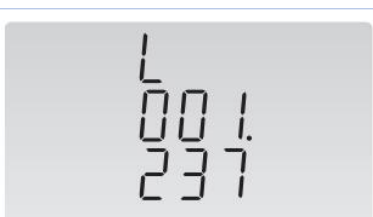

### 3.4.5 Demand Interval Time setup

















Long press button  to enter the setup.

	<p>Press button  and  to set the demand period value.</p> <p>Long press button  to confirm.</p> <p>Option: 5, 8, 10, 15, 20, 30, 60(default),off, Unit: min.</p>
<h3>3.4.6 Backlit Power Time Setup</h3>	
	<p>Long press button  to enter the setup.</p>
	<p>Press button  and  to set the value.</p> <p>Long press button  to confirm.</p> <p>Option: ON, OFF, 5, 10, 30, 60(default), 120 mins ON means backlit always on, OFF means backlit always off.</p>
<h3>3.4.7 System Type Setup</h3>	
	<p>Long press button  to enter the setup.</p>
	<p>Press button  and  to setup the supply system.</p> <p>Option: 3P4W, 3P3W, 1P2W or 1P3W.</p> <p>Long press button  to confirm.</p> <p>Option: 3P4W(default), 3P3W, 1P2W, 1P3W.</p>
<h3>3.4.8 Password Modification Setup</h3>	
	<p>Long press button  to enter the setup mode.</p>

	<p>Press button  and  to enter the new password.</p> <p>Long press button  to confirm.</p> <p>Range: 0000~9999, default 1000.</p>
<h3>3.4.9 Ethernet information setup</h3>	
<h4>3.4.9.1 DHCP function setup</h4>	
	<p>Long press button  to enter the setup mode of TCP IP information.</p>
	<p>Press button  and  to choose DHCP on or off.</p> <p>Default: off</p>
<h4>3.4.9.2 TCP IP address setup</h4>	
	<p>Long press button  to set IP address.</p>
	<p>IP-High 192.168 (default)</p>
	<p>IP-Low 001.200 (default)</p>
<h4>3.4.9.3 Subnet Mask address setup</h4>	

	<p>Long press button  to enter the setup mode.</p>
	<p>Subnet mask-High 255.255 (default)</p>
	<p>Subnet mask-Low 255.0 (default)</p>
<p><b>3.4.9.4 TCP gateway address setup</b></p>	
	<p>Long press button  to enter the setup mode of IP address of TCP gateway</p>
	<p>TCP gateway address - High: 192.168 (default)</p>
	<p>TCP gateway address - Low: 001.001 (default)</p>
<p><b>3.4.9.5 TCP IP Port setup</b></p>	

	<p>Long press button  to enter the setup mode of TCP IP port</p>
	<p>TCP IP port: 502(default)</p>
<p><b>3.4.10 CT Reverse Connect Correction</b>          If the CT is reversely connected, the user does not need to disconnect and reconnect the cables. By this setting adjustment, the meter will automatically adjust the current direction.</p>	
	<p>Long press  to choose the channel.</p>
	<p>Channel selection          Press button  and  to choose channel (CH01-CH04)          Long press  to enter the phase selection interface for CT</p>
	<p>Phase select the phase          Press button  and  to choose the phase (L1, L2, L3).          Long press button  to enter the setup.</p>
	<p>Press button  and  to set the direction.          Long press button  to confirm.          Option: FRD (forward) and REV (reverse), default: FRD.</p>

### 3.4.11 Reset

This function allows user to reset data.



Long press button  to choose channel.



Channel Selection interface

Press button  and  to choose channel (CH01-CH04).

Long press  to enter the reset confirmation interface.



Press button  and  to choose the data type.

Long press button  to confirm. Reset done.

Reset option: Max. demand, Max. value, Min. value

#### Note:

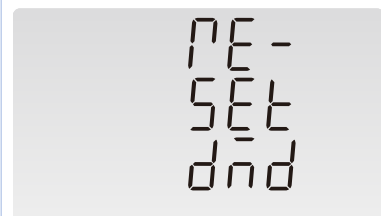

The left interface shows how to reset demand information.



The left interface shows how to reset Max. and Min. values.

## Chapter 4. Connection Diagram for Communication

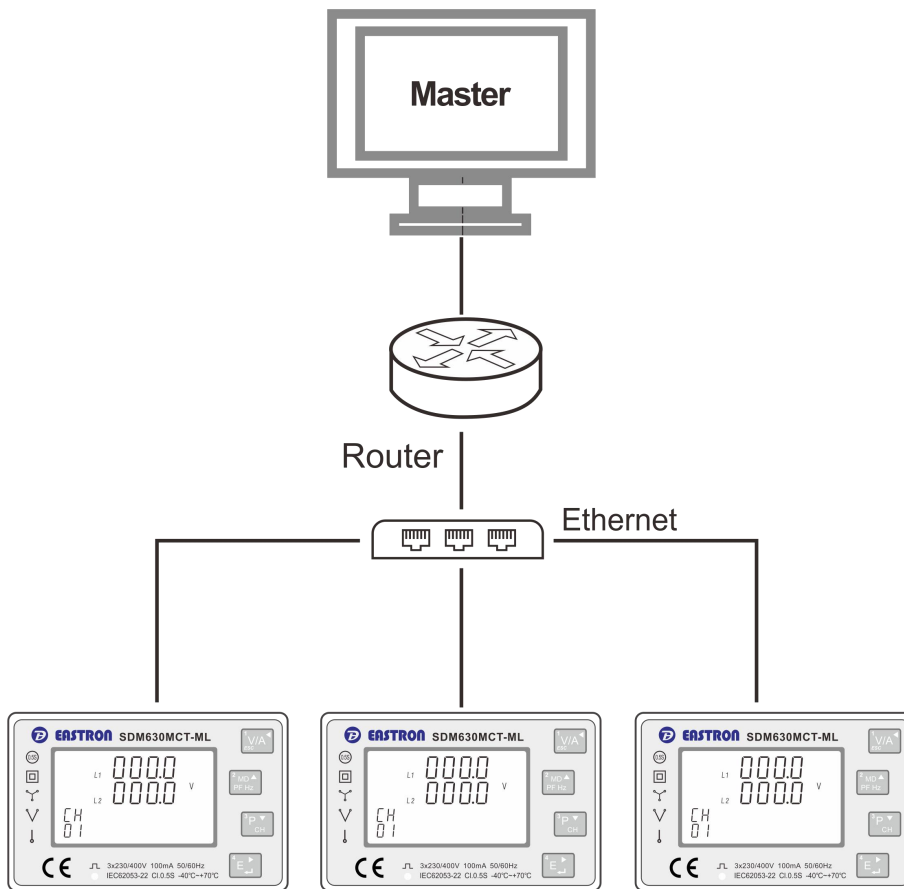

If you have any question, please feel free to contact our sales team.

Zhejiang Eastron Electronic Co., Ltd.  
No.1369, Chengnan Rd. Jiaxing, Zhejiang, 314001, China  
Tel: +86-573-83698881 Fax: +86-573-83698883  
Email: sales@eastrongroup.com  
www.eastrongroup.com