

## SDM72-Bi

### Three Phase 4 Wires Electricity Meter



- Active energy (kWh) + active power (W)
- Bi-directional measurement (Import & export)
- Pulse output
- 100A direct load
- Class 1.0 Accuracy
- 4 modular (72mm)
- 35mm Din rail mounting

## User Manual V1.3

### Application

The SDM72-Bi energy-meters “with a white back-lighted LCD screen for perfect reading” are used to bi-directionally measure renewable energy. The unit measures and displays import and export active energy (kWh) and Power (W). The resettable partial energy is provided, so the user can easily check the energy imported and energy exported during a certain period.

## PART 1 Specification

### General Specifications

Voltage AC (Un)	3x230(400)V
Voltage Range	80~120% Un
Base Current (Ib)	10A AC
Max. Current (Imax)	100A AC
Mini Current (Imin)	0.5A AC
Starting current	0.4% of Ib
Power consumption	<2W/10VA
Frequency	50/60Hz
AC voltage withstand	4KV for 1 minute
Impulse voltage withstand	6KV-1.2uS waveform
Overcurrent withstand	30 Imax for 0.01s
Pulse output rate	1000imp/kWh (default)
Display	LCD with backlit
Max. Reading	999999.9kWh
Active energy	Class 1 IEC62053-21 Class B EN50470-1/3

### Environment

Operating temperature	-25℃ to +55℃
Storage and transportation temperature	-40℃ to +70℃
Reference temperature	23℃ ± 2℃
Relative humidity	0 to 95%, non-condensing
Altitude	up to 2000m
Warm up time	10s
Installation category	CAT III
Mechanical Environment	M1
Electromagnetic environment	E2
Degree of pollution	2

**Mechanics**

Din rail dimensions	72x100x66 (WxHxD) DIN 43880
Mounting	DIN rail 35mm
Ingress Protection	IP51 (indoor)
Material	self-extinguishing UL94V-0

## PART 2 Operation

**Initialization Display**







When it is powered on, the meter will initialize and do self-checking.

	<p>Full Screen (3S)</p>
	<p>Software Version (2S)</p>
	<p>Pulse Constant (2S)</p>
	<p>Total Active Energy(kWh) Total=Import+ Export</p>

Scroll display

There is a button on the front panel of the meter. It can be used to scroll display and reset the partial energy. The function of the button is controlled by the press duration time.

If click the button, the user can scroll down the display for data checking.

	Total active energy(kWh) Total=Import+ Export
	Import energy
	Export energy
	Total partial energy (resettable kWh) Total=Import+ Export
	Import partial energy (resettable import kWh)
	export partial energy (resettable export kWh)

<p>Total</p>	Total power
<p>Imp</p>	Import power
<p>Exp</p>	Export power

**Reset energy**

The button can be used to reset the partial energy. If pressing the button for 3 seconds, the partial energy will be reset to zero.

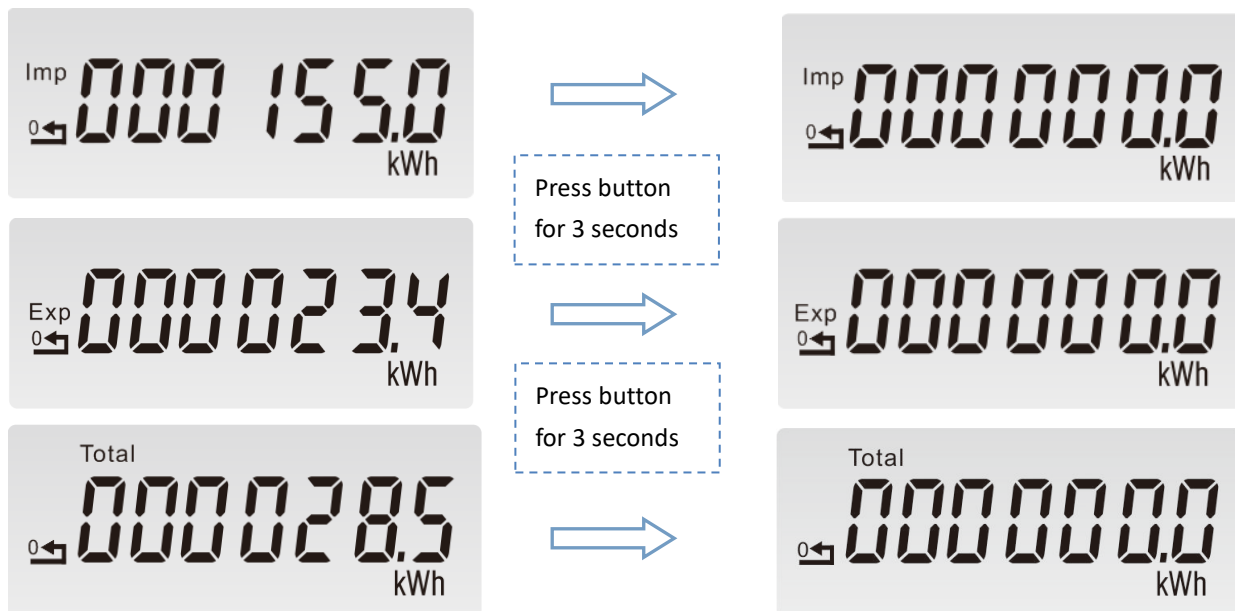

Wiring diagram

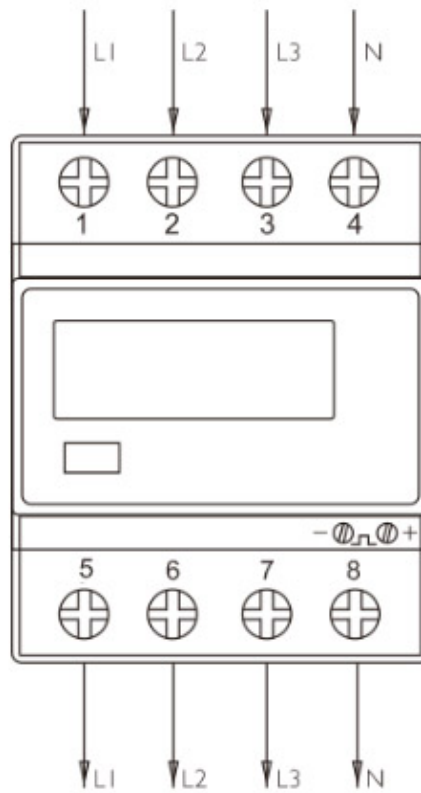

Dimensions

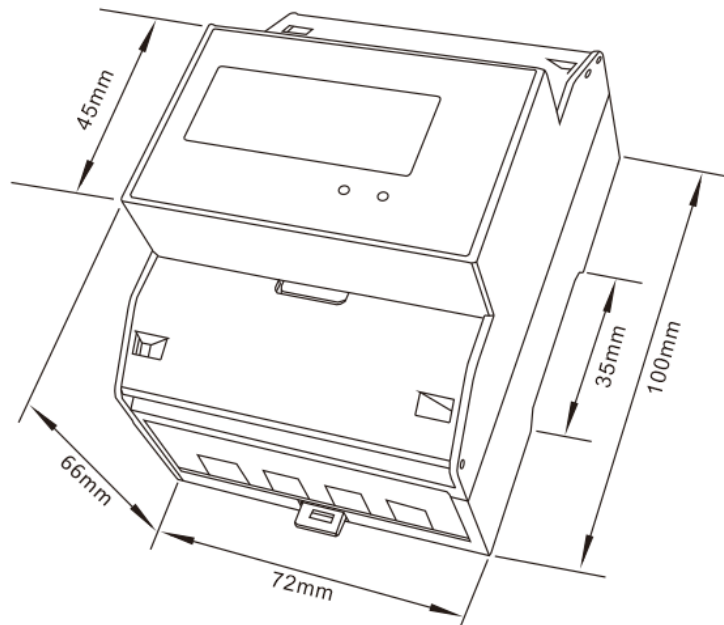

Installation

