

SDM72-DR

Three Phase 4 Wire Electricity Meter



- Active energy (kWh) + active power (W)
- Resettable partial energy
- Pulse output
- 100A direct load
- Class 1.0 Accuracy
- 4 modular (72mm)
- 35mm Din rail mounting

User Manual V1.3

Application

The SDM72-DR energy-meters “with a white back-lighted LCD screen for perfect reading” are used to measure three-phase like commercial and Industrial applications. The unit measures and displays active energy (kWh) and Power (W). A resettable partial energy is provided, so the user can easily check the energy consumption during a certain period. An optional version provide super capacitor to keep the LCD display on when the external power is off.

PART 1 Specification

General Specifications

Voltage AC (Un)	3x230/400V
Voltage Range	80~120% Un
Base Current (Ib)	10A
Max. Current (Imax)	100A
Mini Current (Imin)	0.5A
Starting current	0.4% of Ib
Power consumption	<2W/10VA
Frequency	50/60Hz
AC voltage withstand	4KV for 1 minute
Impulse voltage withstand	6KV-1.2uS waveform
Overcurrent withstand	30 Imax for 0.01s
Pulse output rate	1000imp/kWh (default)
Display	LCD with backlit
Max. Reading	999999.9kWh
Active energy	Class 1 IEC62053-21 Class B EN50470-1/3

Environment

Operating temperature	-25℃ to +55℃
Storage and transportation temperature	-40℃ to +70℃
Reference temperature	23℃ ± 2℃
Relative humidity	0 to 95%, non-condensing
Altitude	up to 2000m
Warm up time	10s
Installation category	CAT III
Mechanical environment	M1
Electromagnetic environment	E2
Degree of pollution	2





Mechanics

Din rail dimensions	72x100x66 (WxHxD) DIN 43880
Mounting	DIN rail 35mm
Ingress Protection	IP51 (indoor)
Material	self-extinguishing UL94V-0

PART 2 Operation

Initialization Display

When it is powered on, the meter will initialize and do self-checking.

	Full screen (3S)
	Software version (2S)
	Pulse constant (2S)
	Total active energy (kWh)

Button function

There is a button on the front panel of the meter. It can be used to scroll display and reset the partial energy. The function of the button is controlled by the press duration time.

If click the button, the user can scroll down the display for data checking.

	Total active energy (kWh)
	Resettable Partial energy (kWh)
	Total power (w)

The button can be used to reset the partial energy. If pressing the button for 3 seconds, the partial energy will be reset to zero.

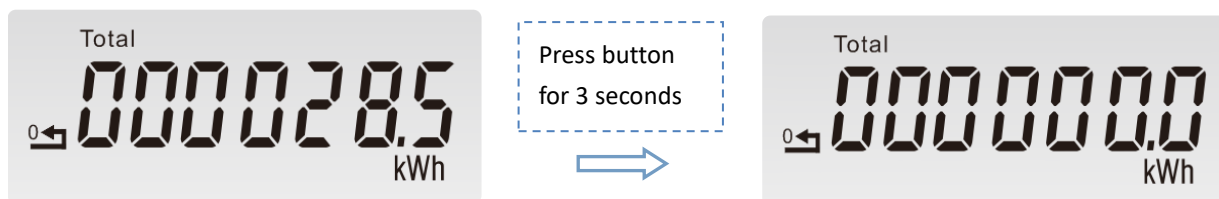

Wiring diagram

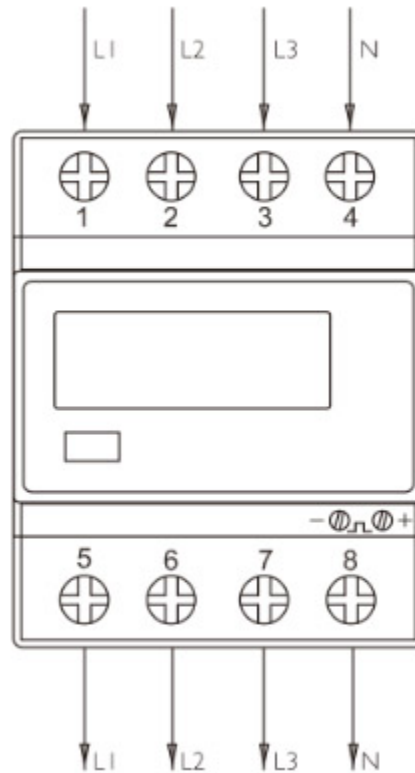

Dimensions

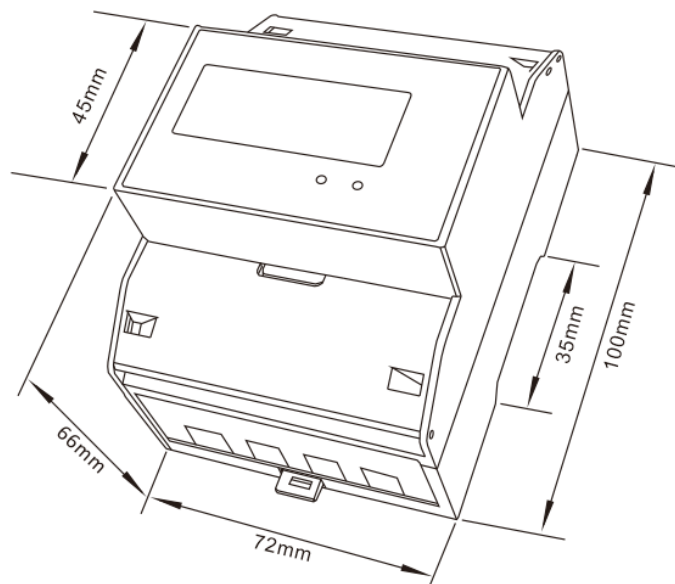

Installation

